

Development of the Large Air Flow, High Static Pressure, and Low Power Consumption DC Fan “San Ace” GV Series

Hiromitsu Kuribayashi

Toshiki Ogawara

Tomoaki Ikeda

Jirou Watanabe

Satoshi Fujimaki

Michinori Watanabe

Shigekazu Mitomo

Kakuhiko Hata

1. Introduction

As for the telecommunication equipment, it is becoming smaller and high performance daily, continuously increasing the heat. It is still necessary to improve the cooling capacity by using large air flow and high static pressure fan. It is also a challenge to decrease the power consumption to prevent the global warming.

“San Ace” G Type, vastly improved air flow compared with conventional products, were developed between 2000 and 2003, and 60 mm sq. × 38 mm thickness, 80 mm sq. × 38 mm thick, 92 mm sq. × 38 mm thick, 120 mm sq. × 25 mm thick, 120 mm sq. × 38 mm thick, etc., were released to the market. These products with top performance in the industry have established a good reputation for the reliability and it was adopted to important equipments supporting the social infrastructures, such as server and telecommunication equipment. Minimization and the high amount of heat in the equipment continued to progress, and a fan with more cooling capacity than the G Type became necessary for some equipments.

To be able to meet these requirements, “San Ace” GV Type, a succeeding model of the G Type, with large air flow, high static pressure, and low power consumption was developed, and released 11 different sized fans into the market.

Some of the characteristics and performance of the “San Ace” GV Type Series are explained in this section.

2. Product Overview

Fig. 1 and Fig. 2 show a photograph and external dimensions of the “San Ace” GV Type fans.

Dimension of the smallest fan is 36 mm sq. × 28 mm thick, and the largest fan is ϕ 172 mm × 51 mm thick. All the control circuit and drive circuit which drives the motor are enclosed in the fan. The stator is placed in the center of the fan, and the rotor is placed outside of it, constructing an outer rotor brushless DC motor. Plastic is used as the material for the blades and frame. However, aluminum is used for the frame for the ϕ 172 mm size. A stator vane with optimal shape for its size was added to the frame.

Single-phase full-wave method was adopted as the motor drive method, and PWM control (speed control) function is installed in all models. PWM signal can be input from the customer equipment to the fan control terminal, then the rotation speed can be controlled arbitrary by changing its duty. Also as an option, there is an alarm terminal, which makes it possible to monitor from the equipment side, to check if the blades are rotating at normal speed.

Table 1 shows the performance specification of all 11 models of the maximum air flow products.

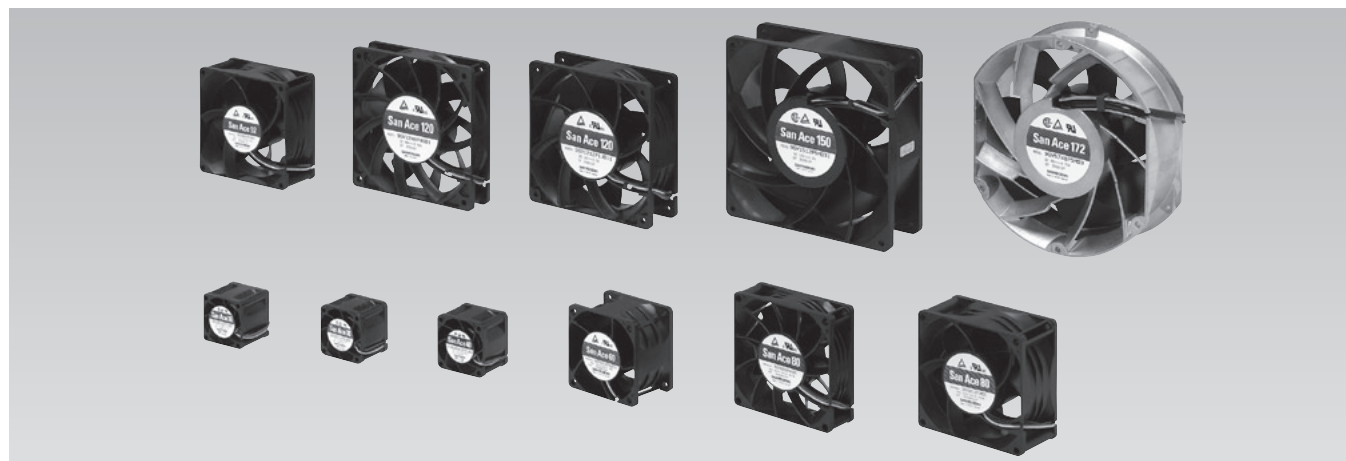

Fig. 1: “San Ace” GV Type Fan

Table 1: Product specification of the “San Ace” GV Type fans (maximum air flow product)

Fan size	Model No.	Rated voltage [V]	Rated current [A]	Rated power [W]	Rated speed [min ⁻¹]	Max. air flow		Max. static pressure		Sound pressure level [dB(A)]	Mass [g]
						[m ³ /min]	[CFM]	[Pa]	[inchH ₂ O]		
36 mm sq. × 28 mm thick	9GV3612P3J03	12	0.75	9.00	19,000	0.55	19.4	525.0	2.11	58.5	46
38 mm sq. × 28 mm thick	9GV0312P3J03		0.60	7.20	15,900	0.57	20.0	315.0	1.27	54.0	50
40 mm sq. × 28 mm thick	9GV0412P3K03		0.84	10.08	16,500	0.76	26.8	419.5	1.69	58.0	50
60 mm sq. × 38 mm thick	9GV0612P1G03		2.80	33.60	16,000	2.37	84.0	751.0	3.02	66.0	130
80 mm sq. × 25 mm thick	9GV0812P4K03		0.87	10.40	5,600	2.12	75.6	173.0	0.69	52.0	125
80 mm sq. × 38 mm thick	9GV0812P1G03		3.80	45.60	10,200	3.90	138.0	490.0	1.97	65.0	220
92 mm sq. × 38 mm thick	9GV0912P1G03		4.10	49.20	9,000	5.35	189.0	430.0	1.73	68.0	250
120 mm sq. × 25 mm thick	9GV1212P4G01		1.68	20.16	5,100	4.83	171.0	224.0	0.90	58.0	260
120 mm sq. × 38 mm thick	9GV1212P1J01		3.00	36.00	6,400	6.35	224.0	360.0	1.45	64.0	360
150 mm sq. × 50 mm thick	9GV1512P5H03		2.90	34.80	3,900	8.54	300.0	210.0	0.84	61.0	450
φ 172 mm × 51 mm thick	9GV5748H501		48	4.00	96.00	6,300	11.32	400.0	690.0	2.77	74.0

Note: Performance at the characteristics of PWM frequency 25 kHz, PWM Duty 100% for the product with PWM control function.

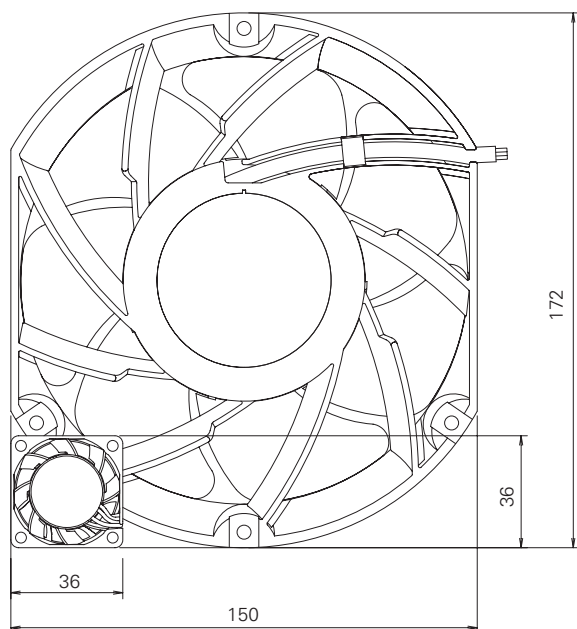

Fig. 2: “San Ace” GV type dimensions (unit: mm)
(36 mm sq. × 28 mm fan and φ 172 mm × 51 mm thick fan)

3. Product features

3.1 Large air flow and high static pressure

With more heat emitted from the equipment, there are cases that cooling performance is not enough with the conventional fans, so motor with higher efficiency was developed for all models, realizing higher rotation speed. At the same time, blades and frame was formed to be most efficient for large air flow and high static pressure. It is the fate of motor to increase the vibration when the speed gets higher, but the vibration was suppressed by reducing the vibration of the motor itself, and increasing the rigidity of the frame. As a result, new product has increased up to 73% in air flow and up to 187% of the static pressure compared to the conventional product. Fig. 3 and Table 2 show the air flow - static pressure characteristics comparison between each model and the conventional product.

3.2 Low power consumption

To decrease the power consumption of the fan, it is necessary to keep the copper loss, iron loss, and mechanical loss of the motor to minimum, and increase the efficiency of the blades to maximum. With the development of the “San Ace” GV Type, all these aspects were reexamined thoroughly, and measures were taken to minimize each loss. Simulations such as electromagnetic field analysis were utilized especially for the reduction of motor loss, challenging for optimization of the magnetic circuit.

As a result, it was possible to reduce up to 28% of the power consumption compared with the conventional product at the same air flow. Table 3 shows the power consumption reduction rate of each model.

Reducing the power consumption of the fan will result in prevention of the global warming and reduction of the running cost.

As an example, if a 60 mm sq. × 38 mm thick fan was operated for 4 years continuously, the difference of the electrical charge between the conventional product and new product will be approximately 2,300 yen in rough estimation. If it is possible to replace 10,000 conventional products with new products, it is calculated to reduce approximately 23 million yen of electrical charge in 4 years.

Table 3: Comparison of power consumption (at same air flow)

Model	Air flow (m ³ /min)	Power consumption		
		Conventional product (W)	New product (W)	Reduction rate (%)
40 mm sq. × 28 mm thick	0.59	6.6	5.2	21
60 mm sq. × 38 mm thick	1.84	18.5	15.2	18
80 mm sq. × 25 mm thick	1.50	4.4	3.7	16
80 mm sq. × 38 mm thick	3.04	21.6	20.3	6
92 mm sq. × 38 mm thick	3.10	13.2	11.1	15
120 mm sq. × 25 mm thick	3.68	10.8	9.5	12
120 mm sq. × 38 mm thick	3.88	11.8	10.7	8
φ 172 mm × 51 mm thick	4.00	51.0	37.0	28

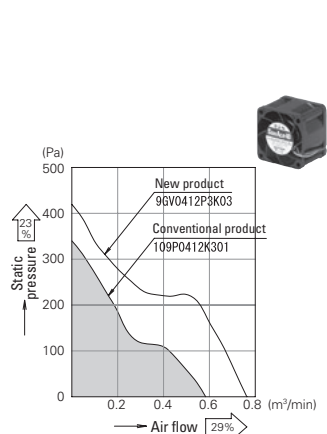

Fig. 3-1: 40 mm sq. × 28 mm thick

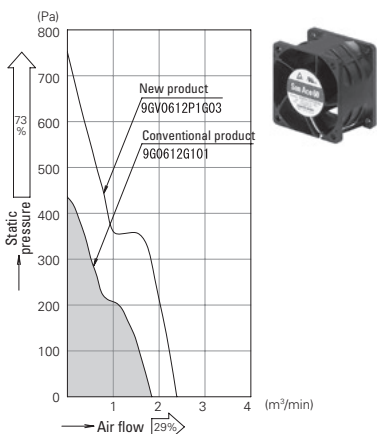

Fig. 3-2: 60 mm sq. × 38 mm thick

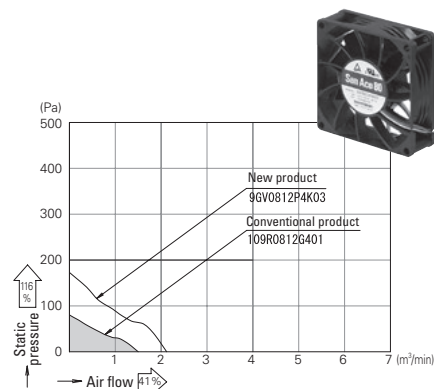

Fig. 3-3: 80 mm sq. × 25 mm thick

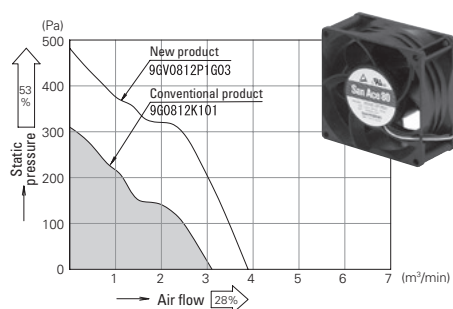

Fig. 3-4: 80 mm sq. × 38 mm thick

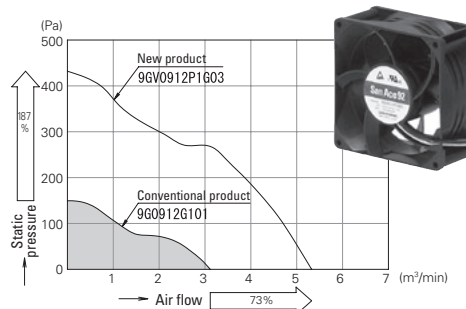

Fig. 3-5: 92 mm sq. × 38 mm thick

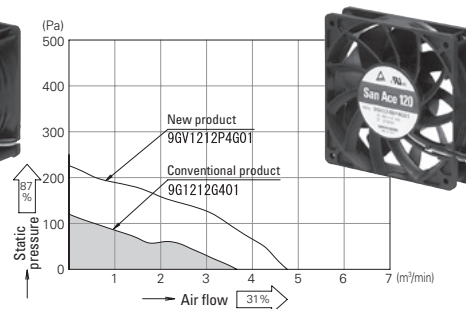

Fig. 3-6: 120 mm sq. × 25 mm thick

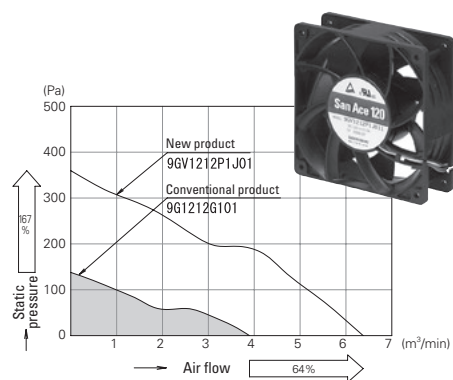

Fig. 3-7: 120 mm sq. × 38 mm thick

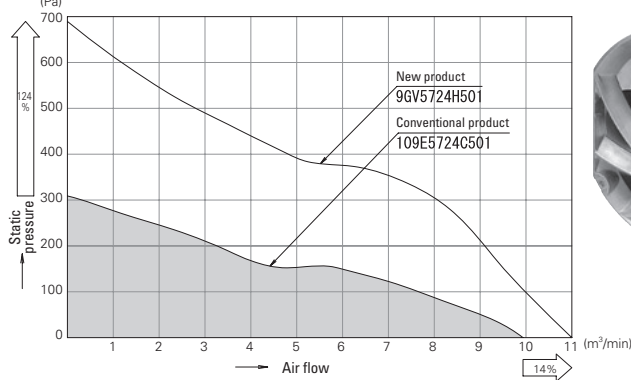

Fig. 3-8: φ 172 mm × 51 mm thick

Fig. 3: Air flow - static pressure characteristics comparison of the conventional products and new products (photograph shows new product)

Table 2: Air flow - static pressure characteristics comparison of the conventional products and new products

Fan size	Model No.	Rated speed [min ⁻¹]	Max. air flow [m ³ /min]	Max. static pressure [Pa]
40 mm sq. × 28 mm thick	New product 9GV0412P3K03	16,500	0.76	420
	Conventional product 109P0412K301	15,500	0.59	340
60 mm sq. × 38 mm thick	New product 9GV0612P1G03	16,000	2.37	751
	Conventional product 9G0612G101	11,800	1.84	435
80 mm sq. × 25 mm thick	New product 9GV0812P4G03	5,600	2.12	173
	Conventional product 109R0812G401	4,500	1.50	80
80 mm sq. × 38 mm thick	New product 9GV0812P1G03	10,200	3.90	490
	Conventional product 9G0812K101	7,800	3.04	320
92 mm sq. × 38 mm thick	New product 9GV0912P1G03	9,000	5.35	430
	Conventional product 9G0912G101	5,000	3.10	150
120 mm sq. × 25 mm thick	New product 9GV1212P4G01	5,100	4.83	224
	Conventional product 9G1212G401	4,100	3.68	120
120 mm sq. × 38 mm thick	New product 9GV1212P1J01	6,400	6.35	360
	Conventional product 9G1212G101	3,600	3.88	135
φ 172 mm × 51 mm thick	New product 9GV5748H501	6,300	11.32	690
	Conventional product 109E5748C501	4,800	9.90	308

Difference in electrical charge:

$$(18.5 - 15.2) \text{ W} \times 24 \text{ (hours)} \times 365 \text{ (days)} \times 4 \text{ (years)} \times 20 \text{ (yen/kWh)} \\ = 2,312 \text{ yen}$$

- Power consumption of conventional product (at 1.84 m³/min): 18.5 W
- Power consumption of new product (at 1.84 m³/min): 15.2 W
- Electrical charge: Assume 20 yen per 1 kWh

3.3 PWM speed control

Equipment including electronic parts responsible of information processing, such as CPU (central processing unit), changes the amount of heat depending on the amount of processing done. In general, heat will be less when there is less information to process, so the air flow of the fan could be made less than normal. We had various fans that can change speed, such as dual speed fans, thermally speed controlled fans, and fans with PWM control (called as PWM control fan hereafter). Out of these fans, speed of the PWM control fans can be controlled precisely, increasing its demand. As an example, temperature within the equipment can be detected by the customer’s side, and the fan speed can be changed by instructing the fan with the PWM Duty in accordance with that temperature. By doing this, it is possible to reduce the power consumption and the noise of the fan, resulting in less power consumption and noise of the whole equipment.

Table 4 shows the example of PWM control fan 60 mm sq. × 38 mm thick GV Type. This fan (9GV0612P1G03) will give its maximum performance when it is running at its rated voltage (12 V) and PWM Duty at 100%, and its power consumption at this point is 33.5 W, and the sound pressure level is 66 dB (A). While the equipment is idling and if there is a margin in the cooling performance, it can drop the input voltage to 8 V and run with the PWM Duty of 0%, its power consumption will reduce to 0.5 W and the sound pressure level will reduce to 13 dB (A).

Table 4: Example of power consumption and sound pressure level reduction with the PWM control function fan (9GV0612P1G03)

	PWM Duty (%)	Speed (min ⁻¹)	Max. air flow (m ³ /min)	Power consumption (W)	Sound pressure level (dB(A))
Input voltage 12V	100	16,000	2.37	33.6	66
	0	3,100	0.44	1.5	25
Input voltage 8V	100	12,050	1.79	13.6	57
	0	1,550	0.23	0.5	13

3.4 High reliability

If a fan is stopped for any reason, there is a chance that it may cause a fatal effect on the function depending on the equipment, so reliability of the fan is very important.

We have long life fans that have expected life of 200,000 hours, and water-proof and oil-proof fans that are used in harsh

environments. Technologies accumulated with development of these fans were actively implemented into the designing of the product during development of the “San Ace” GV Series. While reducing the cost, each of the parts constructing the fan was selected without any compromise.

As a result, comparing to the conventional product, new product has achieved higher speed, and maintains high reliability by achieving 40,000 hours of expected life (L10: 60°C ambient temperature, 90% survival rate, rated voltage, and continuous free air status).

4. Conclusion

Some of the characteristics and performance of the “San Ace” GV Type fans were explained in this section.

Heat and packaging density of the servers and telecommunication equipments are increasing daily, but since the performance of the 11 models of “San Ace” GV Type has the top class performance in the industry, I do believe it will be adopted to many equipments. The power consumption is vastly reduced compared to the conventional products, and with the high reliability, it can contribute to prevent global warming and reduce the running cost.

I would like to thank all the customers who have provided us requests regarding the fans and how the fans were used in their equipment to make this development a success.

We would continually challenge the development of new products that will merit customers and global environment.

Reference

- SANYO DENKI Technical Report Issue 20
Large Air Flow and High Static Pressure “San Ace 40” GV Type
Katsumi Ishihara, Others
- SANYO DENKI Technical Report Issue 21
Large Air Flow and High Static Pressure “San Ace 172” GV Type
Takahisa Toda, Others
- SANYO DENKI Technical Report Issue 22
“San Ace 150” GV Type
Yasuhiro Maruyama, Others
- SANYO DENKI Technical Report Issue 24
Large Air Flow and High Static Pressure “San Ace 36” GV Type
Toshiki Kobayashi, Others



Hiromitsu Kuribayashi

Joined Sanyo Denki in 1996.
Cooling Systems Division, Design Dept.
Worked on the development and design of cooling fans.



Satoshi Fujimaki

Joined Sanyo Denki in 1982.
Cooling Systems Division, Design Dept.
Worked on the development and design of cooling fans.



Toshiki Ogawara

Joined Sanyo Denki in 1984.
Cooling Systems Division, Design Dept.
Worked on the development and design of cooling fans.



Michinori Watanabe

Joined Sanyo Denki in 1989.
Cooling Systems Division, Design Dept.
Worked on the development and design of cooling fans.



Tomoaki Ikeda

Joined Sanyo Denki in 1990.
Cooling Systems Division, Design Dept.
Worked on the development and design of cooling fans.



Shigekazu Mitomo

Joined Sanyo Denki in 1990.
Cooling Systems Division, Design Dept.
Worked on the development and design of cooling fans.



Jirou Watanabe

Joined Sanyo Denki in 1978.
Cooling Systems Division, Design Dept.
Worked on the development and design of cooling fans.



Kakuhiko Hata

Joined Sanyo Denki in 1997.
Cooling Systems Division, Design Dept.
Worked on the development and design of cooling fans.